

NOTE:

1. WRAPS OUTSIDE CORNER, MITRED INSIDE CORNER
OR TERMINATE WITH END CAP.

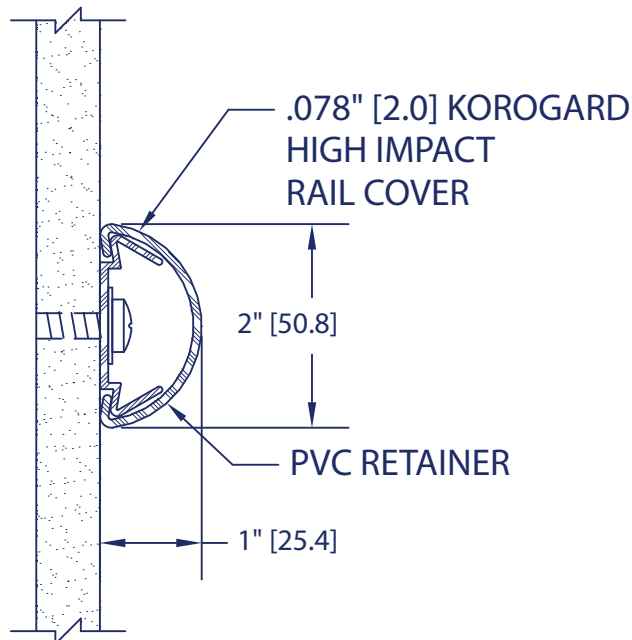

B300, BUMPER GUARD

SCALE: 1:2